



Super Titan XL Owner's Manual

Thank you for purchasing a SnapSafe™ SuperTitan XL.

The ***SnapSafe Modular Assembly System*** offers all the impregnability of a welded safe in an easy-to-assemble modular design. Now, you have the peace-of-mind knowing your valuables are protected from loss due to fire or theft. Best of all, you can easily locate and relocate this protection anywhere, piece-by-piece, to any room, in minutes.

CUSTOMER SERVICE

For all Customer Service questions call toll free:

1-877-214-4470

Or write: SnapSafe Inc. Customer Service

3721 Doubleton Drive, Stuart, FL 34997

Or Email: info@snapsafe.com

SNAPSAFE SUPER TITAN XL FEATURES:

- Delivered right to your door
- Assembles in minutes
- Sledgehammer and pry-bar resistant 3/16" solid steel door
- Thick steel exterior walls
- 2300°F one-hour Fire Shield protection
- Heat activated door fire seals
- 30 slot full gun rack
- Secures 36+ long guns
- Option Between UL Security Listedlocks: Digital or Mechanical
- Eight chrome steel live locking bolts
- Spring-loaded relocker
- Powder coated finish
- Lined interior
- Adjustable lined shelves
- Includes 1 full shelf and full gun rack and a half gun rack with 2 half shelves
- Professional grade "non breach seal" dead bolt door
- Predrilled for floor mounting
- Lifetime warranty

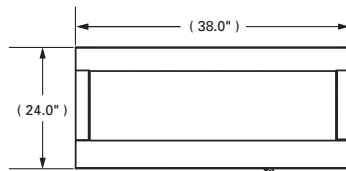

Top and Bottom

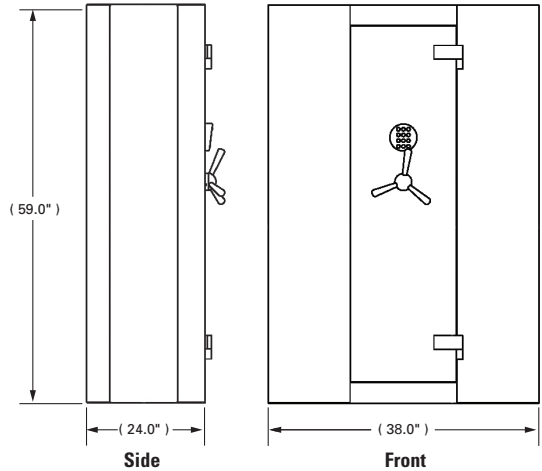

SNAPSAFE SUPER TITAN XL SPECIFICATIONS:

MODEL : SuperTitan XL

EXTERIOR : 59"H x 38"W x 24"D
(add 3" for handle)

INTERIOR : 53 1/2"H x 33"W x 20 1/2"D

DOOR OPENING : 52"H x 14 3/4"W

LOCKING BOLTS : 8

CAPACITY : 36+ Long Guns

WEIGHT : 590 lbs.

ASSEMBLING YOUR SUPER TITAN XL

1. Unpack and lay out all parts.
2. Thread DOOR HANDLE SPOKES (Part #11) onto the hub on DOOR (Part #12).
3. **Install a fresh high-quality 9V battery in the Entry Keypad.** (See pages 8 and 9).
4. **Important – Remove temporary door hinge bolts from door hinges.**
5. Enter the factory combination OR FRAME (Part #6) and set aside.
6. Assemble Top, Bottom and Sides (Parts #1 through #4) first. Then bolt the entire assembly onto the BACK (Part #5).
7. For additional help watch our “Live Action Assembly Video” on the “Features” page at www.snapsafe.com.

Notes:

1. Each part is marked with an assembly number, orientation and instructions.
2. Each part’s orientation e.g. TOP, BOTTOM, FRONT, etc. matches its orientation in the assembled vault. LEFT and RIGHT are as you face the front of the vault.
3. For easier assembly of the nuts, remove the FIRESHIELD blankets from the TOP, BOTTOM and SIDEWALLS. Stuff them back into place before interior assembly.
4. Screw on nuts loosely at first. Once all Exterior Panels are aligned and seated tighten the nuts.
5. The INTERIOR SIDE PANELS are designed to fit snugly. Insert them through the door opening bottom-to-top and then slide into final position front-to-back.
6. Insert the INTERIOR BOTTOM PANEL through the door opening between the front and back shelf strips and then drop into position front-to-back.

BOLTING DOWN YOUR VAULT

We recommend bolting your vault to the floor using two ¼" wedge anchor concrete bolts through the predrilled holes in the BOTTOM of the vault.

DOUBLE SAFEGUARDING VALUABLE PAPERS

Your SnapSafe SuperTitan XL’s Fire Shield protection is rated at 2300°F for one hour. However, we recommend that if you are going to be putting important papers in the vault, you first put it in a fire resistant document box, and then put it in the vault.

YOUR COMBINATION CODE

- Your factory preset combination code is 1-2-3-4-5-6.
- It is recorded in a small envelope wired to the door handle of your vault.
Store this combination in a location other than your vault.

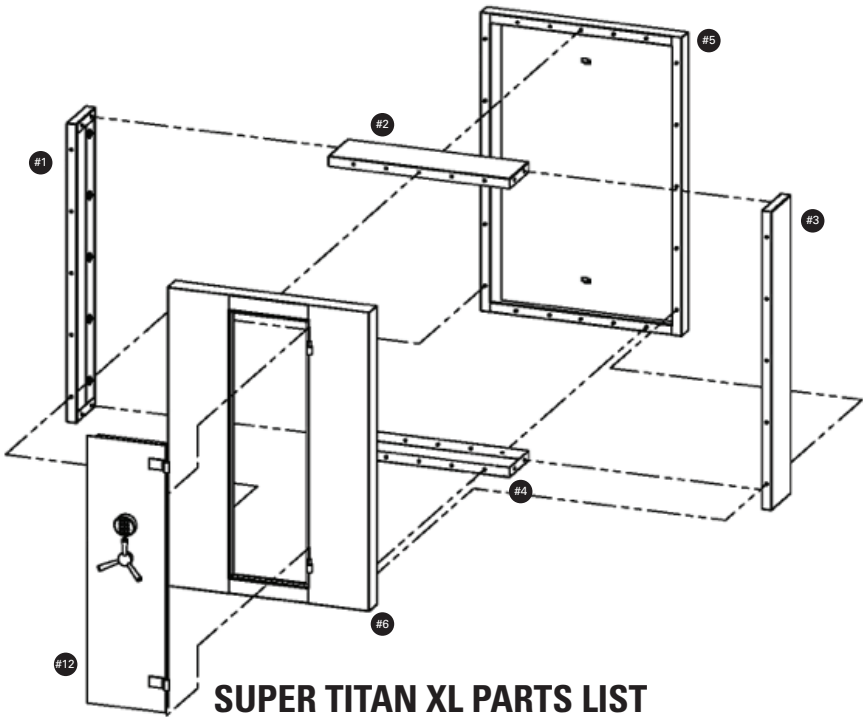

SUPER TITAN XL PARTS LIST

Part #1 – LEFT SIDE	Part #10 – BOTTOM INTERIOR PANEL*
Part #2 – TOP	Part #11 – DOOR HANDLE SPOKES
Part #3 – RIGHT SIDE	Part #12 – DOOR
Part #4 – BOTTOM	Part #15 – SHELF HARDWARE *
Part #5 – BACK	Part #18 – UPPER SHELF*
Part #6 – DOOR FRAME	Part #19 – HARDWARE*
Part #7 – TOP INTERIOR PANEL*	Part #20 – GUN RACK*
Part #8 – LEFT INTERIOR PANEL*	<i>Parts followed by an * are not shown</i>
Part #9 – RIGHT INTERIOR PANEL*	

OPENING AND CLOSING

OPENING:

1. Enter the 6-digit combination code.
2. Rotate 3-spoke handle clockwise into the open position and pull door open.
3. The Entry Keypad relocks in 4 seconds after a valid code has been entered.
4. The Entry Keypad will return to “standby” status with a long beep sound if there is no operation in 10 seconds after the system has been activated.
5. If you enter an incorrect combination 4-times in a row, the lock will shut down for 5-minutes.

CLOSING:

1. Close vault door.
2. Rotate 3-spoke handle counter-clockwise to the closed position until you hear bolts engage.

CHANGING YOUR COMBINATION CODE

Write down and store a new 6-digit code (Do not store in vault). You cannot set the combination code to six (6) zeros (0).

1. Open vault door and lock it in open position.
2. Enter zero (0) six (6) times. One beep sounds indicating the entry is valid and the system is awaiting a code change.
3. Enter the existing 6-digit code. One beep sounds, indicating the entry is valid.
4. Enter a new 6-digit code. One beep sounds, indicating the entry is valid.
5. Re-enter the new 6-digit code. One beep sounds, indicating that the code in step 4 and 5 are the same and that the code change is successful.
6. If three beeps sound, the code change was unsuccessful, and the existing code is still valid. Repeat steps 2 – 5.
7. Enter and check new code 3-times before closing door.

Note: Each step in the code change process must be completed in 10 seconds or the system reverts back to “standby” status.

INSTALLING AND REPLACING ENTRY KEYPAD BATTERY

Your vault is equipped with an electronic lock made with non-volatile memory, meaning your combination code is retained even if the batteries are no longer powering the lock. If this happens, simply replace the batteries.

Install only a high-quality alkaline battery in the compartment in the back of the Entry Keypad following these steps.

1. Remove Entry Keypad. Slide it up and carefully pull it away from the vault door. (Fig.1)

Note: Do not pull the Keypad as too much force may damage the cable.

2. Snap new battery into the connector clip, and slide it into the battery compartment top down so that the wires will not be pinched between the battery and the vault door. (Fig.2)

3. Fold the connection cable inside the Keypad. (Fig.3)

4. Position the keypad over the mounting screws, and slide it down into position.

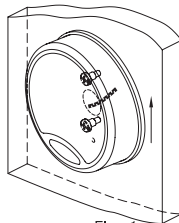

Fig. 1

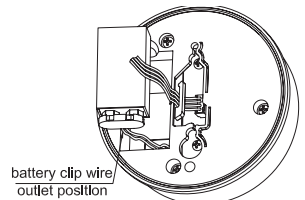

Fig. 2

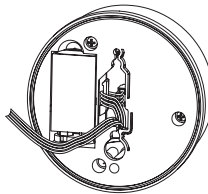

Fig. 3

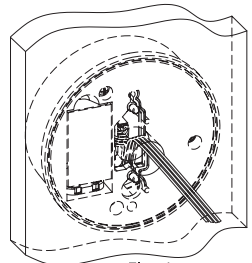

Fig. 4

Note: Make sure the connection cable is not trapped between the Keypad and the door or rubs or tangles on the mounting screws. (Fig.4)

LOW BATTERY ALERT

Your lock has a “Low Battery Alert.” If the Entry Keypad beeps repeatedly during an unlocking, the battery is low and needs immediate replacement.

CARE AND MAINTENANCE

With a little care and maintenance your SnapSafe Modular Vault will last a lifetime. Keep the door hinge pins lightly greased so that the door opens smoothly. Vacuum the inside from time to time, and wipe down the outside with a soft cloth and mild detergent. Never use harsh solvents or abrasives on any surfaces, as they may damage the exterior finish or interior materials.

SNAPSAFE LIFETIME WARRANTY

Were going to take care of you.

Period.

We have built products and a company we are proud of and want you to be as well.

If you ever experience a fire or attempted break-in we'll repair or replace your vault at no charge. *(All you have to do is to forward the report from the proper investigative agency.)*

IMPORTANT!

Keep for Your Records.

Do not store this booklet and information in your vault.

Date of receipt of vault _____

Vault serial number _____

(Located on the plate in the lower right corner of the front of the vault)



Customer Service: **3721 Doubleton Drive Stuart, FL 34997**
1-877-214-4470 | Email: info@snapsafe.com