



10 SHOOTING SAFETY RULES

WARNING: FAILURE TO FOLLOW THESE RULES CAN RESULT IN SERIOUS INJURY, PARTICULARLY TO THE EYE.

1

Always keep the muzzle pointed in a safe direction.

There are several safe "carries" depending on the situation.

NEVER ALLOW THE MUZZLE TO POINT IN THE DIRECTION OF A PERSON.

2

Treat every gun as if it were loaded.

You can never be positive that you were the last person to handle the gun. Never take anyone's word about whether or not a gun is loaded. Always check a gun to see if it is loaded when removed from storage or received from another person. Even if you have fired an airgun one or more times and no pellet or BB was expelled from the barrel, it does not mean that the magazine of the gun is empty of ammunition. Any airgun can fail to feed for any number of reasons. Continue to treat the airgun as loaded and ready to fire. **ALWAYS TREAT A GUN AS IF IT IS LOADED EVEN IF YOU KNOW IT ISN'T.**

3

Only load or cock a gun when you are shooting.

A loaded gun has no place in your home or other public place.

4

Check your target and beyond your target.

Be sure all persons are well clear of the target area before you shoot. Check behind and beyond your target to be certain you have a safe backstop and that no person or property could be endangered.

5

Anyone shooting or near a shooter should wear shooting glasses.

Also, all other persons should remain behind the shooter.

6

Never climb or jump with a gun.

You can't control the direction of the muzzle if you stumble or fall. You should safely lay the gun down or hand it to a companion while you climb or jump over anything.

7

Avoid ricochet.

Never shoot at a flat hard surface or at the surface of water. Ammunition can ricochet off of water just like a skipped rock.

8

Keep the muzzle clear.

Never let anything obstruct the muzzle of a gun. Don't allow the muzzle to come in contact with the ground.

9

Guns not in use should always be unloaded.

Keeping guns unloaded when not in use is critical to the safety of you and others. When you are finished shooting, put the trigger safety in the "on" position and unload the gun. Store guns so that they are inaccessible to untrained shooters and store ammunition separately from the gun.

10

Respect other people's property.

Whether you're target shooting or hunting, if you're a guest on others' land, you should leave it exactly as you found it.

Visit www.daisy.com and read the shooting safety rules. Take a quiz and get your "Take Aim at Safety" Certificate.

Daisy[®]
FIRST IN AIRGUNS.

Daisy Outdoor Products

Rogers, AR 72757-0220 U.S.A.
800-643-3458 • www.daisy.com

Operation Manual

Daisy[®]
FIRST IN AIRGUNS.

840 Series Air Rifles Single-pump Pneumatic

BB Cal. (4.5mm) Steel Airgun Shot ☉

.177 (4.5mm) Lead Airgun Pellet ☐



Daisy Grizzly 840



Daisy Grizzly 840C



Daisy 841



Avanti Mentor 845

WARNING: DAISY RECOMMENDS LEAD-FREE PELLETS FOR SHOOTERS 12 YEARS OF AGE OR UNDER.

WARNING: NOT A TOY. ADULT SUPERVISION REQUIRED. MISUSE OR CARELESS USE MAY CAUSE SERIOUS INJURY, PARTICULARLY TO THE EYE. MAY BE DANGEROUS UP TO 216 YARDS (197 METERS).

READ ALL INSTRUCTIONS BEFORE USING. THE PURCHASER AND USER SHOULD CONFORM TO ALL LAWS GOVERNING USE AND OWNERSHIP OF AIR GUNS. AIR GUNS ARE RECOMMENDED FOR USE BY THOSE TEN YEARS OF AGE OR OLDER UNDER ADULT SUPERVISION.

ACCORDING TO CALIFORNIA LAW

WARNING: DO NOT BRANDISH OR DISPLAY THIS AIRGUN IN PUBLIC - IT MAY CONFUSE PEOPLE AND MAY BE A CRIME. POLICE AND OTHERS MAY THINK THIS AIRGUN IS A FIREARM. DO NOT CHANGE THE COLORATION AND MARKINGS TO MAKE IT LOOK MORE LIKE A FIREARM. THAT IS DANGEROUS AND MAY BE A CRIME.

WARNING: THIS GUN CAN CAUSE THE LOSS OF AN EYE IF MISUSED OR CARELESSLY USED. READ AND FOLLOW THE INSTRUCTIONS. DO NOT COCK THE GUN UNTIL YOU ARE READY TO SHOOT. IF YOU DO COCK IT AND DECIDE NOT TO SHOOT, POINT IT IN A SAFE DIRECTION AND FIRE IT. AN UNCOCKED, UNLOADED GUN IS THE SAFEST. ACCIDENTS HAPPEN FAST, AND THE LOSS OF AN EYE IS A TERRIBLE THING. SHOOT SAFELY.

This safety alert symbol indicates important safety messages in this manual. When you see this symbol, be alert to the possibility of personal injury and carefully read the message that follows.

It is your responsibility as the owner of this gun to make certain that anyone using the gun is instructed in its safe and proper operation.

As the proud owner of a Daisy air gun, you have become part of an American tradition which dates back to the time when your great-grandfather was a small boy. Your new Daisy gun is the result of more than 100 years experience by Daisy in the manufacture of quality products.

Although your new Daisy is not a firearm, it is a gun and should be treated with care and respect. Always remember, the first and most important safety aspect of any gun is the shooter. All safeties are mechanical devices and the shooter is the only part of the system that can make a gun safe--or unsafe. **DON'T DEPEND ON MECHANICAL SAFETIES.** Think ahead and avoid situations that might lead to accidents.

FOR YOUR SAFETY AND THE SAFETY OF OTHERS, READ COMPLETE OPERATING INSTRUCTIONS BEFORE ATTEMPTING TO SHOOT GUN. Guns differ in their operations and you are never ready to fire any gun until you are thoroughly familiar with it. Read the operating instructions and **WITHOUT LOADING ANY AMMUNITION**, proceed several times through the operating steps with your gun (dry fire the gun at a safe target) so that you will be able to operate the Model 840/841/845 properly and safely.

HOW TO OPERATE

CAUTION: Be sure gun is always pointed in a safe direction.

- Step 1: PUT "ON" TRIGGER SAFETY
- Step 2: OPEN BOLT
- Step 3: PUMP (ONCE)
- Step 4: LOAD
- Step 5: CLOSE BOLT
- Step 6: AIM AT SAFE TARGET
- Step 7: TAKE "OFF" TRIGGER SAFETY
- Step 8: FIRE

STEP 1. PUT "ON" TRIGGER SAFETY

Push trigger safety from left to right so no red is showing. It is a good practice to get in the habit of keeping the trigger safety "ON" until ready to fire the gun. (Fig. 2)

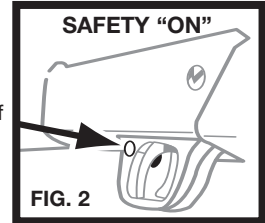

FIG. 2

STEP 2. OPEN BOLT

Tilt muzzle down about 30° and pull bolt handle rearward. The gun cannot fire with the bolt open. (Fig.3)

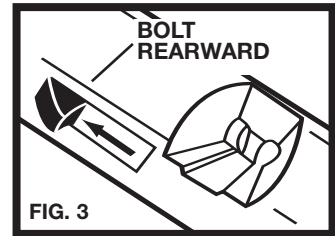

FIG. 3

STEP 3. PUMP ONE TIME

IMPORTANT: Do not pump more than one time. May cause serious damage to your gun. This gun was designed and intended as a single pump. For greater safety, we recommend that the bolt remain open while pumping, and that you close the bolt only when the barrel can be pointed in a safe direction. Grasp the forearm at rear and pull down and forward as far as possible, then return forearm to original closed position. (Fig. 4)

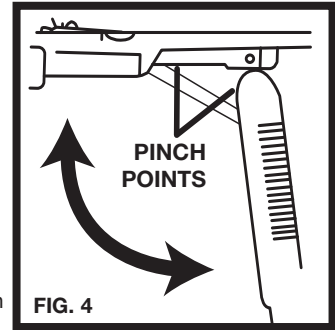

FIG. 4

CAUTION: Be sure to grasp forearm firmly as you close the lever to prevent it from snapping back and causing possible injury. Also, be careful to keep fingers out of cocking mechanism when closing lever (See "PINCH POINTS", Fig. 4). Never put your finger on the trigger until you are ready to fire.

FILL BB MAGAZINE

The loading door is located on the left side of the receiver. (Fig. 1) Push door rearward and fill magazine with a maximum of 350 BBs. Then close door.

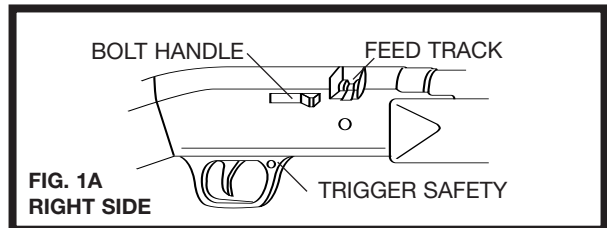

FIG. 1A
RIGHT SIDE

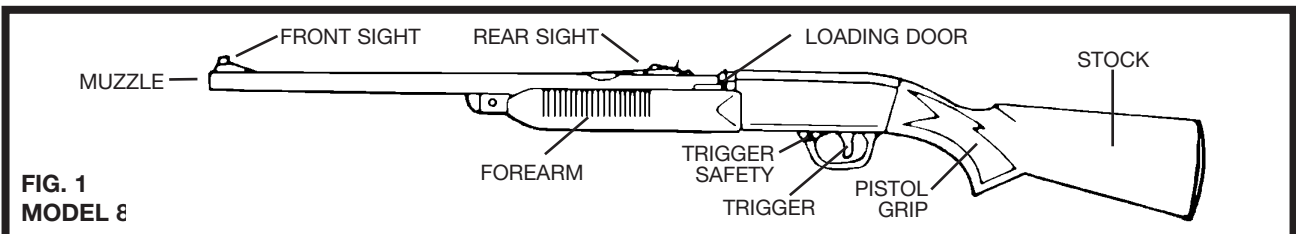

FIG. 1
MODEL 8

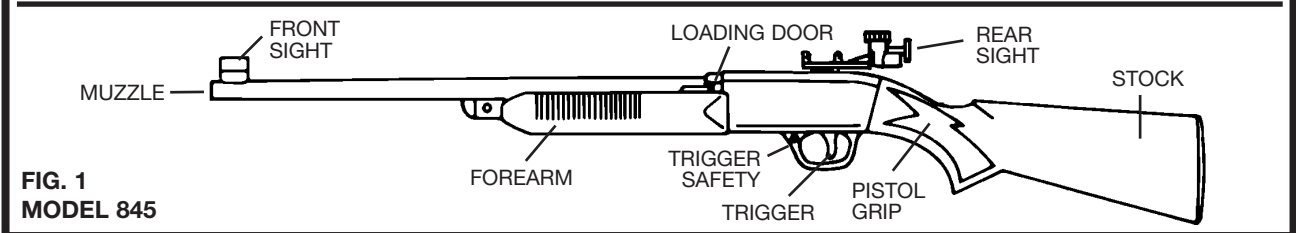
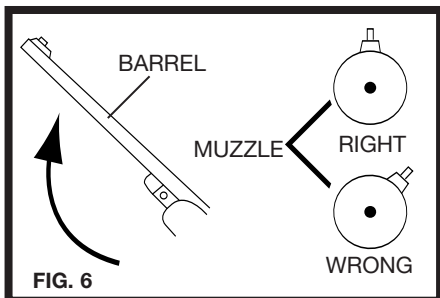
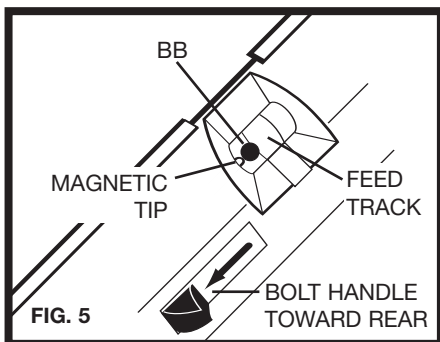

FIG. 1
MODEL 845

STEP 4. LOAD

LOADING BBs: To load a BB from the magazine, raise the muzzle 45 degrees to 60 degrees and pull the bolt handle fully to the rear. (Fig. 5) A BB is gravity fed onto the magnetic tip of the bolt (Fig. 5) When raising the muzzle, be sure the



front sight is pointed upward, because the gun will not feed properly if it is on its side. (Fig. 6) The BB can be seen on the magnetic tip (after the bolt handle is released) by looking into the feed track. If a BB did not feed onto the magnetic tip, shake the gun slightly and repeat the "LOADING BBs" instructions.

WARNING: BBs feed from the magazine by gravity which requires that the muzzle be raised. **NEVER ASSUME THE MAGAZINE OR CHAMBER IS EMPTY**, even if the gun does not fire a projectile.

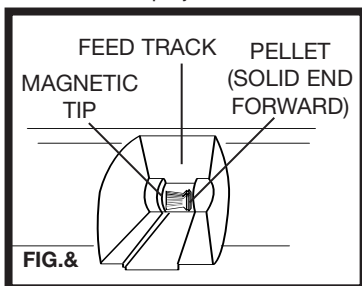

LOADING PELLETS: With BBs removed from the magazine (See "EMPTY BB MAGAZINE, Page 5), lower muzzle slightly and pull bolt handle rearward. Then place a pellet (solid end forward) in feed track. (Fig. 7)

IMPORTANT: Care must be exercised when shooting pellets while the magazine contains BBs. Loading a BB and pellet at the same time may result in a jammed or obstructed barrel.

IMPORTANT: Do not allow a pellet to fall into the rear of the feed track and become jammed in the BB feed hole. If this occurs, have a qualified gunsmith remove the left receiver and clear the feed track, or return the gun to Daisy. **DO NOT** load pellets in the BB loading door.

STEP 5. CLOSE BOLT

CAUTION: Gun must always be pointed in a safe direction.

Push bolt handle forward. The gun is now loaded and should be handled with care.

CAUTION: Always view the BB or pellet when closing the bolt and loading port.

STEP 6. AIM AT SAFE TARGET

CAUTION: Pick targets that cannot be penetrated and that will not cause a ricochet because of their hard surface. Do not shoot at water. Never point a gun, loaded or unloaded, at anyone.

To be a consistent marksman, use the correct sight picture each time you fire the gun. (Fig. 8)

PROPER SIGHT PICTURE FOR 840 Series Air Rifles:

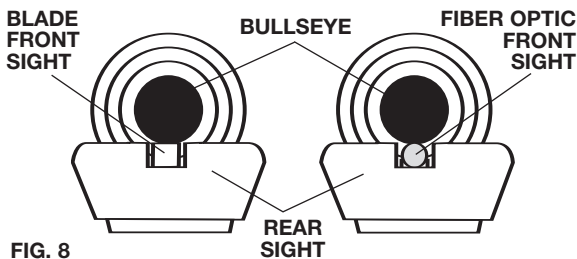

SIGHT ADJUSTMENT

Your 845 Target BB gun is equipped with a hooded front sight with four interchangeable inserts, and a precision rear peep sight. (See instructions packed with the sight.)

You will have to experiment with the interchangeable front inserts to determine which is best for you.

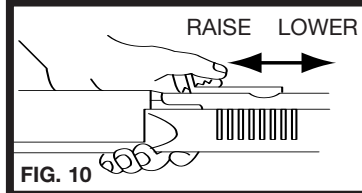
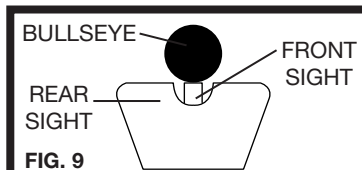

The Model 840/841 is equipped with a rear sight that is adjustable for elevation. Raise the rear sight to make the gun shoot higher. Lower the rear sight to make the gun shoot lower. (Fig. 9 & 10)

STEP 7. TAKE "OFF" TRIGGER SAFETY

When you are certain the target, backstop and surrounding area is safe, push the trigger safety from right to left until red band is exposed. (Fig. 11)

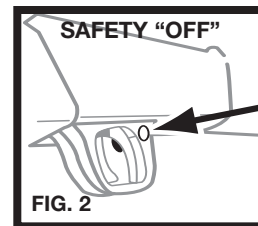

STEP 8. FIRE

After completing the operation steps, your gun may be fired by gently, but firmly, squeezing the trigger. **NOTE:** The bolt must be completely closed, as indicated in Step 5. **IMPORTANT:** Do not leave the gun pumped up for more than one hour or damage to the gun could result.

WARNING: If a BB or pellet does not fire after completing the operation steps, the gun is jammed. This is a dangerous condition. Keep gun pointed in a safe direction and repeat all operation steps except Step 4. If a projectile still does not fire, do the following:

1. Put the trigger safety "ON SAFE" (no red showing).
2. Open bolt.
3. Clean barrel by running a cleaning rod through from the muzzle end. Be careful not to damage the bolt tip by pushing the rod through too hard. Do not reuse this BB or pellet.
4. Repeat operation steps.

If after following the firing procedure the BB or pellet still does not fire, your gun should be returned to the factory (See "Repair of Daisy Guns" section).

EMPTY BB MAGAZINE

Put "ON" trigger safety. Open BB loading door, cup your hand under it and turn gun fully to its left side. Shake gun until all BBs are removed. To make sure no BBs remain in the feed system, raise the muzzle, shake gun, and work the bolt forward and **all the way back** several times, removing any BBs that appear.

CAUTION: Never assume the gun is empty of projectiles. Always point the gun in a safe direction.

UNLOAD PELLET

The bolt does not extract a pellet. You must put the trigger safety "ON", pull the bolt back, insert a cleaning rod in the muzzle end of the gun and push the pellet out. Be careful not to damage the bolt tip by pushing the rod through too hard.

AMMUNITION

Use only BBs or .177 cal. (4.5mm) pellets that are labeled as such. **DO NOT** use buckshot, ball bearings, or other foreign objects, as they could damage or jam your gun.

PROPER CARE

The exposed metal parts (barrel, lever, screwheads, etc.) should occasionally be wiped clean, using a soft cloth lightly oiled with clean motor oil. Use a 10, 20, or 30 weight non-detergent

automotive motor oil. **DO NOT** use light, household-type oils or aerosol-type spray lubricants, since they may contain substances or additives harmful to the rubber seals or other components.

The pump piston has a felt wiper ring that should occasionally be oiled. Invert the gun and fully open the forearm lever. You will see "Oil Here" and an arrow pointing to the felt wiper which can be seen through a slot in the forward end of the pump tube. Add two drops of oil to the felt wiper after each 2,000 shots. The forearm lever pivot joints should be sparingly lubricated by occasionally adding one drop of oil to each pivot point. (Fig. 12)

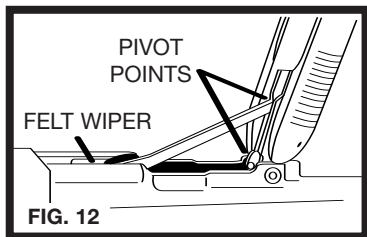

STORAGE

Unload ammunition and store it in a separate place from the gun to keep away from untrained shooters. Before putting the gun away in a cabinet or gun rack, shoot the gun at a safe target to make sure the pump system and barrel are empty. Then, put "ON" trigger safety. Always make sure the gun is empty and the trigger safety "ON" before storage; also, the gun should be clean, dry and oiled.

MODIFICATION

WARNING: The components of this gun were engineered to deliver optimum performance. Any modification of tampering with a gun may cause a malfunction and may make it unsafe to use. Any change in performance, such as lowered trigger force and shortened trigger travel, indicates possible wear and such gun should be inspected, replaced or properly repaired by qualified personnel. Any gun that has been dropped should be checked by qualified personnel to insure that its function has not been affected.

REPAIR OF DAISY GUNS

WARNING: A GUN THAT IS NOT OPERATING PROPERLY MAY BE DANGEROUS. IT SHOULD BE KEPT SAFELY FROM USE BY ANYONE UNTIL REPAIRED OR DESTROYED. DO NOT TRY TO TAKE THE GUN APART. IT IS DIFFICULT TO REASSEMBLE, AND IMPROPER REASSEMBLY CAN CAUSE A HAZARDOUS CONDITION.

GUNS IN WARRANTY

LIMITED ONE YEAR WARRANTY

For one year from date of purchase, Daisy will repair or replace this gun, free of charge, if defective in material or workmanship. Service is available by returning the gun to Daisy Outdoor Products. Attach to the gun your name and address and telephone number, description of problem and proof of date of retail purchase (sales slip). Package and send to Daisy Outdoor Products, transportation prepaid. This Warranty gives you specific legal rights, and you may also have other rights which may vary from state to state.

GUNS OUT OF WARRANTY

If your Daisy needs repair, call Customer Service at 1-800-713-2479 for repair or replacement charge. We accept Visa and Mastercard. When paying by check or money order, please send with gun. Attach to the gun your name, street address (Not Post Office Boxes) and description of the problem. Package and send, transportation prepaid, to Daisy Outdoor Products, Service Department. Daisy will repair the gun or replace it with a reconditioned gun of the same model, if available, otherwise with a model of equivalent quality.

Exploded gun part drawings and price lists are available from Daisy Service Department. Please make sure you state model number stamped on barrel. Service and parts charges are subject to change without notice.

**Daisy Outdoor Products
Service Department
308 West Stribling Drive
Rogers, AR 72756**

NOTE: We recommend returning guns via UPS.

SPECIFICATIONS - Models 840, 841 & 845

ACTION	Single pump pneumatic
CALIBER	.177 cal. (4.5mm)
AMMUNITION	BB cal. (4.5mm); .177 cal. (4.5mm) PELLET
BB CAPACITY	350 BBs
VELOCITY	BBS: 335 fps (102mps); PELLETS: 300 fps (91mps)
TARGET DISTANCE	BBS: 16.4 ft. (5m); PELLETS: 33 ft. (10m)
MAXIMUM SHOOTING DISTANCE*	BBS: 216 yds. (197m); PELLETS: 183 yds. (167m)
WEIGHT	2.2 lbs. (1.0kg)
SIGHTS - FRONT	840,841: Blade and ramp; 845: Hooded with aperture inserts
- REAR	840,841: Open leaf, adjustable elevation; 845:Adjustable rear peep
BARREL	Smooth bore steel, 19 in. long (48.3cm)

* With muzzle pointed up at the optimum angle.

Daisy[®]
FIRST IN AIRGUNS.



**An Introduction
to Daisy[®] Airgun
Shooting**

A MESSAGE TO PARENTS

Although not a firearm, a Daisy airgun is a gun and not a toy. Properly used and maintained, it will provide many hours of safe, trouble free recreational shooting. Misused, it can be dangerous. Therefore, we recommend it be used only under adult supervision and never by a young person less than ten years of age. On the back cover of this operation manual are **10 Shooting Safety Rules**. We urge you to read them with your child, practice them and review them often.

As the proud owner of a new Daisy gun, your child has become part of an American tradition dating back more than 100 years. Mechanically, a new Daisy is backed by nearly a century of engineering know-how and experience in the manufacture of quality products.

Safe gun handling depends upon proper safety training, and instilling in your son or daughter the right attitude toward gun ownership. To help you, we have designed this booklet to cover the basic facts every young person should understand before shooting a gun. Take time to study it thoroughly with your child. A proper understanding of these basics will greatly increase your youngster's enjoyment of the lifetime sport of recreational air gun shooting and, at the same time, give you the satisfaction of knowing your child is properly prepared to handle an air gun.

We strongly urge a formal course of instruction in Shooting Education for your child. There are a number of youth and civic organizations which offer a complete 10-lesson course based on guidelines developed by the training experts at Daisy, and they are listed in the section "Learn to shoot safely" on page 13 of this book. A quick check with them will let you know when the next course will be starting in your area. If you would like more detailed information, write: Special Market Programs, Daisy, P.O. Box 220, Rogers, Arkansas 72757.

GETTING STARTED

First, you should know that your Daisy is not a toy. It's a gun. If you use it carefully, it will provide many years of enjoyment. But, if you aren't careful, it can be dangerous.

Second, read this book. In conjunction with the Operation Manual, it tells you how to handle your new BB gun properly and how to have the most fun with it. Read it carefully with a parent and make sure you all understand it. Then, put what you've learned into practice. And remember, it's your responsibility as a gun owner to make certain that anyone using it is instructed in the rules of proper gun handling.

SAFE GUN HANDLING IS THE KEY TO SHOOTING FUN

If you understand that "HANDLING" your gun means every time you touch it, and if you remember always to handle a gun as if it were loaded, then you are well on your way to proper gun handling. A majority of air gun accidents in this country are caused by 1) careless and improper handling of the gun, 2) believing the gun to be empty when it isn't, or 3) shooting at improper targets. All three causes can be avoided if the shooter handles the gun properly.

For years we have been teaching the 10 Shooting Safety Rules. Read, remember, practice and review these few simple rules. They will help you enjoy many hours of safe, fun, recreational shooting.

10 SHOOTING SAFETY RULES

1. **Always keep the muzzle pointed in a safe direction.**
2. **Treat every gun as if it were loaded.**
3. **Only load or cock a gun when you are shooting.**
4. **Check your target and beyond your target.**
5. **Anyone shooting or near a shooter should wear shooting glasses.**
6. **Never climb or jump with a gun.**
7. **Avoid ricochet.**
8. **Keep the muzzle clear.**
9. **Guns not in use should always be unloaded.**
10. **Respect other people's property.**

It is also very important for you to remember that any time you receive a gun from anyone, or take a gun from its storage place, you should make sure it's unloaded and uncocked by pointing it in a safe direction and pulling the trigger.

⚠ WARNING: EVEN IF YOU HAVE FIRED THE AIRGUN ONE OR MORE TIMES AND NO BB WAS EXPELLED, IT DOES NOT MEAN THAT THE GUN IS EMPTY OF BBs. CONTINUE TO TREAT THE AIRGUN AS IF IT IS LOADED.

Never look into the muzzle of your gun. You can't tell by looking if your gun is loaded, so always treat it as if it were. Habits which you form now in handling your new Daisy will be helpful in the handling of any gun.

THE OUTDOOR DAISY

Your Daisy airgun isn't designed for hunting, but you can still have outdoor fun with it. It's easy to set up an outdoor range (SEE SAFE TARGETS).

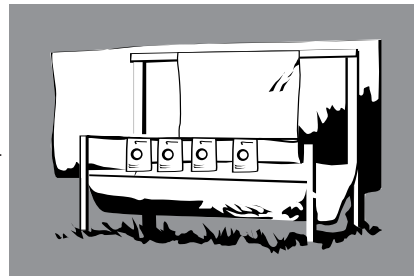

In fact, outdoor shooting is a great way for a young person and his or her parents to have some real family fun and competition.

When you are carrying a Daisy airgun outdoors, keep the following things in mind:

- Don't shoot at targets with a hard surface, like rocks or trees. Your BB could ricochet. Never shoot at the surface of water for the same reason.
- Always be sure you know where other people are before you shoot. Make sure they're clear of the target.
- Keep the muzzle always pointed in a safe direction so if you stumble and fall you can control the direction of the muzzle.
- Keep your Daisy airgun unloaded when you are not using it.
- Indoors or out, it's a good idea for the shooter and anyone near to wear shooting glasses for extra eye protection. (They can be purchased at most stores selling sporting goods.)

THE INDOOR DAISY

A Daisy airgun is safe for indoor shooting as long as you observe the proper safety rules. There aren't many, but they are important. First, you must have at least 5 meters (16.4 ft.) of space from the firing line to the target. All Daisy Youth Line air rifles are designed with controlled velocity of less than 350 feet per second and are most effective for target shooting at 5 meters. (It takes as much skill to shoot a Daisy on a 5 meter range as it takes to shoot a .22 on a 50 foot range!) Second, you must have a safe target (See "SAFE TARGET" section) placed so there are no entry ways in front of the firing line or behind the targets. If this is not possible, then doorways in the areas should be blocked. Third, you should have a canvas or blanket behind the target which hangs free from the wall and clears the floor. This will prevent ricochet should you miss the target. Finally, your target should be well lighted.

Remember to keep your Daisy unloaded until the target is up and you are ready to shoot. Never point it in any direction except toward the target.

If you follow these rules and combine them with the other tips on proper gun handling in this book, you can enjoy safe, indoor Daisy airgun shooting.

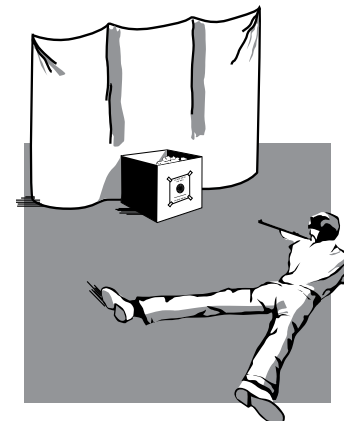

A DAISY BB GUN IS NOT FOR HUNTING

It's a target-shooting gun. But it teaches you the skill and safety habits you'll need for hunting.

Or, you might prefer preparing yourself for match target shooting. Many adult gun owners do.

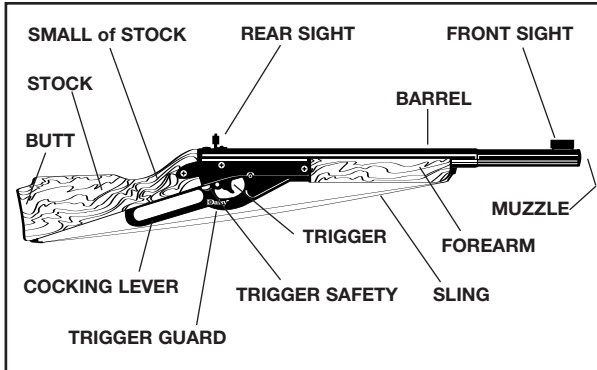

GET TO KNOW YOUR DAISY FROM BUTT PLATE TO MUZZLE

Do you know what the trigger guard is? The forearm? Check your knowledge with the picture.

HOW TO BECOME AN EXPERT MARKSMAN

If you learn the techniques, and practice regularly, you can become a real marksman.

Marksmanship will provide you with a lot of enjoyment all your life. The tips you'll pick up in this book will get you started. But you'll learn faster by getting some help from an adult who is an experienced shooter.

POSITIONS

There are four basic rifle shooting positions and two variations of each. Learn them all so you will be prepared for any shooting conditions. The positions are prone, sitting, kneeling, and standing.

Half face to the right before getting into any position. Then:

PRONE - Lie at an angle of about 5 to 15 degrees to the line of fire. The left leg should be completely relaxed. The right leg should angle away from the spine and may be bent or straight.

KNEELING - Half face to the right, then drop to the right knee. In the low position, the left foot should be extended as far forward as is comfortable, while the right leg is flat on the ground with foot flat and rotated inward, with shooter sitting on side of right foot. In the high position, the shooter sits on his right heel.

SITTING - In the low position, cross your legs in front of you with the outside of each foot resting on the ground and supporting the knees. Elbows should be placed near the knees forming triangles to support the rifle. Legs are not crossed in the high position. The feet are well spread, with the heels braced, and the body leaning forward so the elbows may be braced over the knees.

STANDING - In the Army standing position, half face to the right with feet spread about a foot apart. Stand relaxed, not rigid. The right elbow should be at about the same height as the shoulder. Your left arm does not touch your body.

In the N.R.A. standing position, you may rest your left upper arm against your body on your hip.

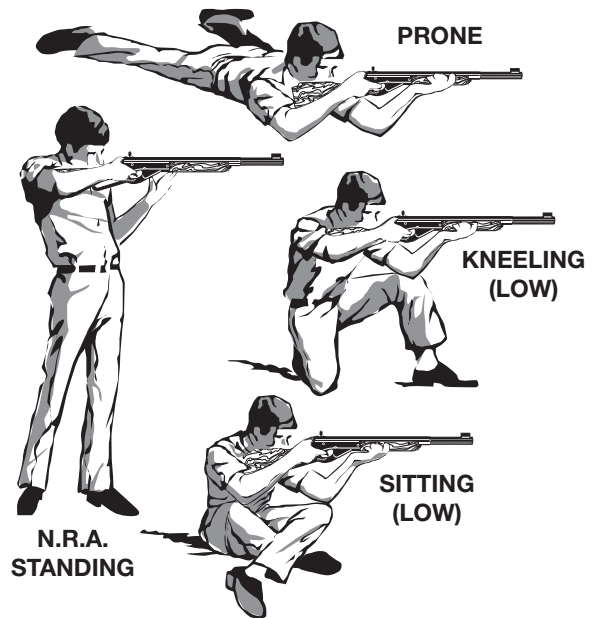

NOW GET YOUR BB GUN IN PROPER POSITION

These simple rules will help you hold your rifle correctly. (Instructions are for a right handed person—reverse for left handed person.)

1. Grasp the small of the stock with your right hand.
2. Let the forearm rest on the palm of your left hand (or on the thumb and fingertips if using the N.R.A. standing position).
3. Place your left elbow as close to directly under your gun as possible.
4. Place your cheek as far forward on the stock as possible without straining and press gently against the stock.
5. Now make sure your Daisy still points effortlessly at the center of the target. To make sure, close your eyes and point it where you think the target is. If, when you open your eyes, the gun is pointing away from the center of the target, shift your body to correct. Repeat until naturally centered.
6. Prepare to squeeze the trigger with the first joint of your first (index) finger. **But don't fire yet!**

AIMING (OR SIGHTING)

A Daisy will shoot where you aim it. The trick is holding the proper sight picture. To do this, think about a lollipop. Then make the front sight the lollipop stick, and the bullseye the candy! Keep the top of the lollipop stick even with the top of the rear sight and centered in the V notch.

Try sighting. Then check what you see against the sight pictures above.

To be a consistent marksman, use the correct sight picture each time you fire the gun, and remember - sight or point the gun only in a safe direction.

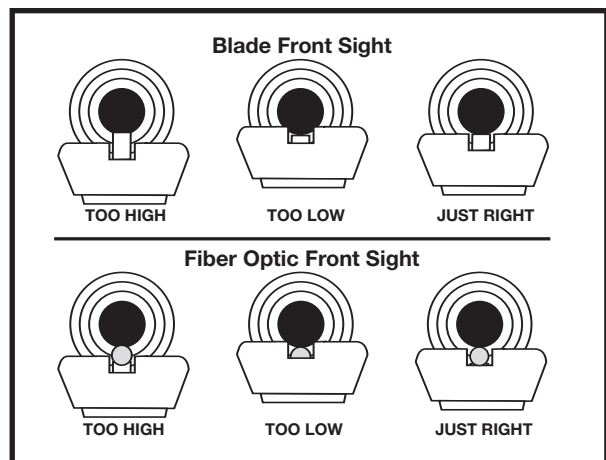

BREATHING

Breathing at the wrong moment can cause your body to move, and your aim to go astray. So breathe properly. Here's how:

- (a) **Take a long breath.**
- (b) **Let out half. Aim.**
- (c) **Hold the rest until after you've fired.**

But don't fire yet!

FIRING

This consists of two steps: Aiming and Squeezing. Get your sights in line and watch carefully. As the tip of the sight arrives at the bottom of the bullseye, gradually squeeze the trigger. Never jerk the trigger. The sudden movement will ruin your aim. Trigger squeezing takes practice. But keep trying. You'll get it down to an art.

Now you are ready to fire.

But wait a moment!

What are you firing at? Where are you firing?

Remember the 10 Shooting Safety Rules - Be sure of your target before you shoot. Never carry a cocked gun. Cock it only when ready to fire. Even with the trigger safety in the ON position, your gun is in fully loaded condition and must be handled with care.

SIGHTING-IN YOUR GUN

The first step in proper sight alignment is to determine the shot grouping of your new Daisy. To do this, position a rest, such as a table or bench, 5 meters from your target. Place your rifle on the rest, and, aiming at the same point on the target each time, fire three shots. Do not attempt to make any adjustments during the three shots.

At this point you are only interested in how well your shots group. Once you have determined the grouping ability of you and your rifle, you can then adjust your sights to bring the group on target. NOTE: It may be necessary for each person shooting your Daisy air gun to realign the sights to fit his sight pattern.

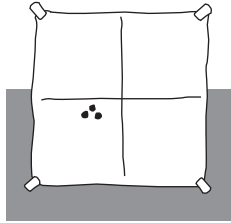

HOW TO MAKE AN INDOOR-OUT-DOOR TARGET

A cardboard box 16 inches or more deep, and with at least two-foot square front surface, will serve as the basis for the target. Center 3 inches of tightly bound magazines (do not substitute newspapers) on the inside back wall of the box opposite the target, and fill the box with tightly packed, crumpled newspaper to prevent ricochet. Once the backstop is complete, tape the target to the front of the box. **Do not use metal fasteners—ammunition can ricochet.** As the target is used, the backing must be watched closely and should be replaced when the ammunition has penetrated half the thickness of the magazines.

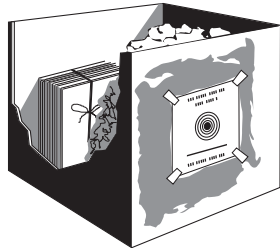

CAUTION: Whether you purchase a target trap or make your own, it is important to remember that **they will wear out** with continued use. Because of this, you should always place your backstop where it will be safe should it fail and check it carefully before and after each use. A rebound or ricochet is an indication that the backstop is faulty and that you should stop using it immediately.

SHOOTING GAMES

Once you've mastered the basics, you can try a few shooting games like these:

1. **TIC-TAC-TOE.** Two shooters take one-shot-turns, and mark each hit. Play like regular tic-tac-toe.
2. **MISS-N-OUT.** Set up ten targets. Shoot until you miss. Shooter with most shoots wins.
3. **HIT-AND-MOVE-BACK.** Each shooter takes one step back every time he hits the target. Farthest back wins.

IMPORTANT: Be sure you are using a safe backstop behind all targets!

USE THE RIGHT AMMUNITION

Your new Daisy is designed to use only steel BBs or pellets (.177 cal. / 4.5 mm). Load your gun with clean, new Daisy BBs. If dirty, deformed, used BBs, oversized balls or other foreign objects are used, your gun will not feed correctly and may jam, possibly resulting in serious injury.

When buying ammo for your gun, be sure to look for this label: **BB cal. (.177 cal. / 4.5mm) Steel Air Gun Shot or .177 cal. / 4.5mm pellets.**

Steel shot will fire at a higher velocity than lead shot with the same muzzle energy. As a result, more caution is required when using steel shot (i.e. BBs or lead-free pellets).

Remember: Use only proper shot in your airgun and do not reuse shot.

WHEN YOU'VE FINISHED SHOOTING

One of the most important rules of proper gun handling is NEVER STORE A LOADED GUN. When you have finished shooting, unload your gun. The Operation Manual which came with your new Daisy tells you how. Before putting your gun away in a cabinet or gun rack, make sure it is clean, dry, oiled, empty, and uncocked. BBs should be stored in a separate place to keep them away from untrained shooters.

LEARN TO SHOOT SAFELY

Daisy Outdoor Products has a rich heritage of teaching young and first time shooters to shoot safely. In order to effectively implement shooting education programs nationwide, Daisy has partnered with the following organizations which teach shooting safety and provide additional shooting safety materials and information. We encourage you to contact Daisy at 1-800-643-3458 or one of these organizations to sign up for a shooting safety class in your area.

PROGRAM MATERIALS & EQUIPMENT

Daisy Outdoor Products
800-713-2479
www.daisy.com

PROGRAM INFORMATION

American Legion Junior Shooting Sports Program
317-630-1249
www.legion.org

NRA Youth Programs
800-672-3888 ext. 1505
www.nrahq.org/youth

Daisy / Jaycees Shooting Education Program
The United States Junior Chamber of Commerce
800-529-2337
www.usjaycees.org

4-H Shooting Sports
Contact your County Extension Agent
www.4-h.org

Junior Olympic Shooting Program
719-866-4670
www.usashooting.com