



**Phantom
Model CS1K77A/CS7M77A
.177 cal Air Rifle**

OWNER'S MANUAL

READ ALL INSTRUCTIONS AND WARNINGS IN THIS MANUAL BEFORE USING THIS AIRGUN

Crosman Corporation
7629 Rts. 5 & 20
Bloomfield, NY 14469 USA
800-7-AIRGUN
www.crosman.com
Made in USA with some foreign components

CS1K77A-515

WARNING: Not a toy. This air gun is recommended for adult use only. Misuse or careless use may cause serious injury or death. May be dangerous up to 600 yards (594 m).

WARNING: Do not brandish or display this air gun in public—it may confuse people and may be a crime. Police and others may think it is a firearm. Do not change the coloration and markings to make it look more like a firearm. That is dangerous and may be a crime.

YOU AND OTHERS WITH YOU SHOULD ALWAYS WEAR SHOOTING GLASSES TO PROTECT YOUR EYES.

READ ALL INSTRUCTIONS BEFORE USING.

BUYER AND USER HAVE THE DUTY TO OBEY ALL LAWS ABOUT THE USE AND OWNERSHIP OF THIS AIRGUN.

THIS AIRGUN IS INTENDED FOR USE BY ADULTS ONLY.

WARNING: This product contains one or more chemicals known to the state of California to cause cancer and birth defects or other reproductive harm. Wash hands after handling.

WARNING: This air gun has been classified as an adult gun, and is recommended for adult use only. Because it is considered to be a special-purpose air gun, it is exempt from specific types of trigger pull, safety mechanisms and drop tests.

Read this owner's manual completely. And remember that an air gun is not a toy. Always carefully follow the safety instructions in this owner's manual and keep the manual in a safe place for future use. If you have any questions regarding the operation of your new air gun contact Crosman at 1-800-724-7486.

1. Learning the Parts of Your New Air Gun.

Learning the parts of your new air gun helps you understand your owner's manual. Use this manual to increase your enjoyment of this air gun.

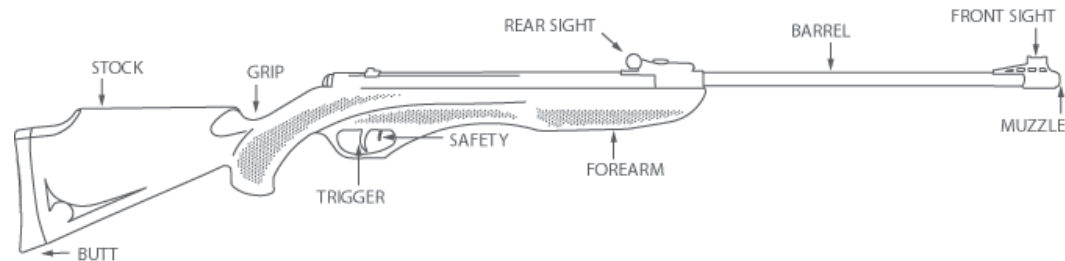

Break in Period

There may be up to a 100 shot break-in period. During this period accuracy may be inconsistent and your gun may seem loud. This will improve as the spring breaks in.



2. Operating the Safety

A. To Put the Air Gun "ON SAFE:"

- Locate the safety in front of the trigger.
- The letters "F" (fire) and "S" (safe) on the bottom of the trigger guard indicate the appropriate position of the safety.
- Push the safety towards the trigger to put the safety on. The safety is on, and the air gun is "ON SAFE" when the lever is in the rear position (near the trigger). (Fig. 2)

Even when the safety is on, you should continue to handle the air gun safely. Don't point the gun at anything you don't intend to shoot.

Like all mechanical devices, an air gun safety can fail. Even when the safety is "ON SAFE", you should continue to handle the air gun safely. NEVER point the air gun at any person. NEVER point the air gun at anything you do not intend to shoot.

B. To Take the Air Gun "OFF SAFE"

WARNING: Keep the air gun "ON SAFE" until you are actually ready to shoot. Then push the safety to the "OFF SAFE" position.

- Push the safety to the forward position (away from the trigger). When the air gun is "OFF SAFE" (Fig. 2) it is ready to be fired after following the instructions in this manual on how to load.

3. Adjusting the Trigger

This air gun has a trigger with a screw for adjustment of the second stage length (Fig. 3)

Note: This feature is added for advanced shooters. Most shooters can use the settings provided during manufacturing of the gun and should not need to make any modifications.

- Make sure air gun is "ON SAFE", unloaded and not cocked.
- To reduce the second stage length, rotate the adjusting screw counterclockwise.
- To increase the second stage length, rotate the adjusting screw clockwise.

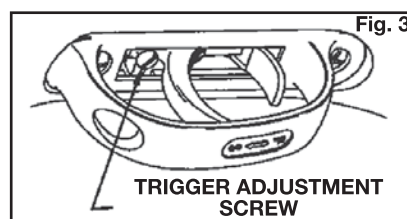

4. Cocking and Loading Your Air Gun

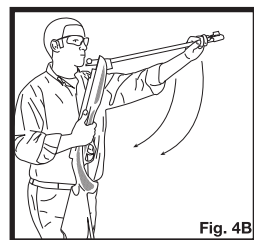
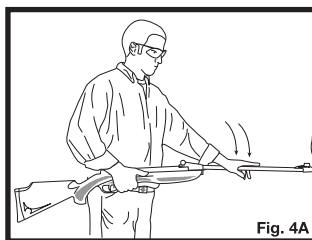

A. Cocking Your Air Gun

WARNING: Make sure you do not touch the trigger or push the safety to the "OFF SAFE" position.

Do not cock your air gun until you are ready to load and fire, since the only way to un-cock your air gun is to fire it. Firing your gun without a pellet in the chamber (dry firing) may cause damage to your air gun.

- Put the air gun "ON SAFE" (SECTION 2).
- Point the air gun in a SAFE DIRECTION.
- Holding the gun close to your body, firmly tap the muzzle. (Fig. 4A)
- Anchor gun against thigh and pull barrel down as far as it will go to engage the spring. (Fig.4B)
- Be careful not to pinch your hand or fingers in the hinge area of the air gun.

B. Loading Your Air Gun

WARNING: Make sure you do not pull the trigger while cocking the air rifle or with the barrel in the down position. This may cause serious damage to the air rifle.

CAUTION: Use .177 caliber pellets only in your Phantom. Never reuse ammunition. Your air gun was designed to work with Crosman branded ammunition, these include Crosman® and Benjamin. Use of any other ammunition can cause injury to you or damage to the air gun.

There may be up to a 100 shot break-in period. During this period accuracy may be inconsistent and your gun may seem loud. This will improve as the spring breaks in.

- With the barrel in the open position, after it has been cocked, place one pellet, nose forward, into the breech (Fig. 5). Make sure that the skirt of the pellet is flush with face of breech.
- Move the barrel back to its original position by pushing the barrel up until it locks (Fig. 6).
- Be sure that the barrel is locked in the closed position after loading/cocking to help ensure better accuracy.

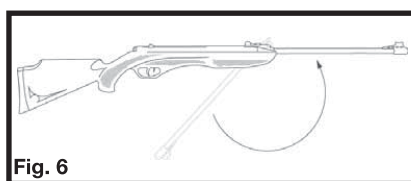
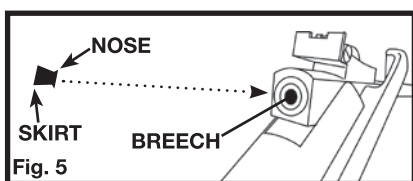

Once again, be careful not to pinch your hands or fingers. Be sure the air gun is "ON SAFE" and pointed in a safe direction.

WARNING: Your air rifle is now loaded and ready to fire. Keep the air rifle "ON SAFE" until you are ready to shoot. Do not point at anything you don't intend to shoot.

C. Unloading Your Air Gun

Do not cock and load your air gun until you are ready to shoot since the only way to un-cock your air gun is to fire it in a safe direction. REMEMBER, choose your targets carefully and be sure that the area around the target is clear. THINK what you will hit if you miss the target! Do not store your gun cocked or loaded.

5. Aiming and Firing Safely

A. Aiming and Firing the Air Gun

- You and others with you should always wear shooting glasses to protect your eyes.
- Always aim your air gun in a SAFE DIRECTION.
- Do not shoot at hard surfaces or at the surface of water. The pellet may bounce off or ricochet and hit someone or something you had not intended to hit.
- Always choose your target carefully. It is best to shoot at paper bull's-eye targets which are attached to a safe backstop. A heavy blanket should be hung behind the backstop to prevent ricochet should you miss the backstop.
- Your backstop should be checked for wear before and after each use. Replace your backstop if the surface is worn or damaged or if a ricochet occurs.
- Your air gun is designed for target shooting. Always remember to place your target carefully.
- THINK about what you will hit if you miss the target.
- When you are sure of your target and backstop, and the area around the target is clear, take the air gun "Off Safe" (see Section 2.2) and pull the trigger to fire.

6. Removing a Jammed Pellet

- Put your air gun "ON SAFE" (Section 2A).
- Do not reload the air gun if a pellet is jammed.
- Break the barrel open slightly (without pulling the barrel all the way down to the point that it cocks the action) and look down the breech to see if the gun is jammed.
- If it is jammed, insert a cleaning rod into the breech and push the jammed pellet out of the muzzle. Don't try to reuse that pellet (Fig. 7)

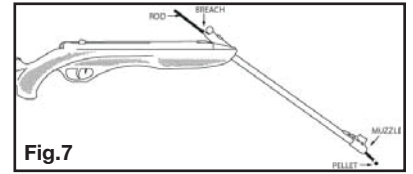

WARNING: Do not cock the air gun during the removal of a jammed pellet unless you plan on continuing to shoot.

Remember: do not fire your air gun without a pellet in the chamber (dry fire). This may permanently damage your air gun.

- If you are not able to unjam your air gun by following the unloading procedure, take no further action. An Authorized Service Station will unjam your air gun (no cost during the warranty period).

7. Maintaining Your Air Gun

- Periodically tighten all stock fasteners
- Check and tighten scope mounts if applicable
- To ensure that your air rifle maintains uniform power, it is important that you apply a drop of Crosman RMC OIL every few hundred shots into the compression chamber. (Fig. 8) The external metal parts should be cleaned with a cloth that has RMC OIL on it.

CAUTION: Use Crosman RMC OIL only and do not over-oil. To do so can cause possible damage to the gun and injury to the shooter and bystanders.

CAUTION: Do not attempt to disassemble your air gun. DO NOT MODIFY OR ALTER YOUR AIRGUN. Attempts to modify the air gun in any way inconsistent with this manual may make your air gun unsafe to use, cause serious injury or death, and will void the warranty.

If you drop your air gun, visually check to see that it works properly before you use it again. If anything seems changed, like a shorter or weaker trigger pull, this may mean worn out or broken parts. Call Crosman customer service for assistance before using your air gun again.

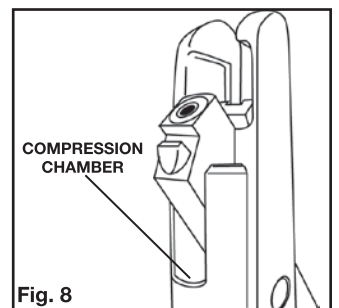

8. Reviewing Safety

- Never point the air gun at any person or at anything you do not intend to shoot.
- Always treat the air gun as though it is loaded and with the same respect you would a firearm.
- Always aim in a SAFE DIRECTION. Always keep the muzzle of the air gun pointed in a SAFE DIRECTION.
- Always keep the air gun on safe until you are ready to shoot.
- Always check to see if the air gun is "ON SAFE" (see section 2A) and unloaded when getting it from another person or from storage.
- Always keep your finger off the trigger and out of the trigger guard until ready to shoot.
- You and others with you should always wear shooting glasses to protect your eyes.
- If your reading or prescription glasses are not safety glasses, make sure you wear shooting glasses over your regular glasses.
- Use .177 caliber (4.5mm) pellet only in your Model Phantom. NEVER reuse ammunition.
- Do not shoot at hard surfaces or at the surface of water. The pellet may bounce off or ricochet and hit someone or something you had not intended to hit.
- Place the backstop in a location that will be safe should the backstop fail.
- Your backstop should be checked for wear before and after each use. All backstops are subject to wear and will eventually fail. Replace your backstop if the surface is worn or damaged or if a ricochet occurs.
- Do not attempt to disassemble or tamper with your air gun. Use an Authorized Service Station. Using unauthorized repair centers or modifying the function of your air gun in any way may be unsafe and will void your warranty.
- Before you store your air gun make sure it is not loaded or cocked.
- Whenever you store the air gun, make sure it is "ON SAFE" (see section 2A.)

SPECIFICATIONS

Mechanism	Break Barrel	Length	43.00"
Power source	Spring	Velocity	CS1K77A
			• Up to 1200fps with high velocity pellet • Up to 1000fps with standard pellet.
Caliber/ammunition	.177 cal pellet	Safety	CS7M77A
			• Up to 695 fps
Weight	5.84 lbs	Ambidextrous Lever	

PERFORMANCE

Many factors can affect velocity, including brand of projectile and weight of projectile.

Your air gun was designed to work with Crosman branded ammunition, these include Crosman® and Benjamin®. Use of other ammunition may cause your gun to malfunction.

Break in Period

There may be up to a 100 shot break-in period. During this period accuracy may be inconsistent and your gun may seem loud. This will improve as the spring breaks in.

STOP DO NOT RETURN THIS PRODUCT TO THE STORE.

Our friendly customer service representatives will be glad to help. You can get answers to frequently asked questions at www.crosman.com or you can contact us directly at 1-800-7AIRGUN (1-800-724-7486)

REPAIR SERVICE

If your air gun needs repair, we recommend you take or send it to your nearest Crosman Authorized Service Station. DO NOT ATTEMPT TO DISASSEMBLE IT! Your air gun requires special tools and fixtures to repair it. Any disassembly or modification not performed by an Authorized Service Station will void the warranty.

A SPECIAL CUSTOMER SERVICE

Crosman Authorized Service Stations will unjam your air gun at no cost during the warranty period.

LIMITED ONE YEAR WARRANTY

This product is warranted to the retail consumer for one year from date of retail purchase against defects in material and workmanship and is transferable. To register the serial number of your air gun return the air gun registration form. The warranty is not conditioned on the return of the card. You should retain the original sales receipt as record of date of purchase.

WHAT IS COVERED

Replacement parts and labor. Transportation charges to consumer for repaired product.

WHAT IS NOT COVERED

Transportation charges to Authorized Service Station for defective product. Damages caused by abuse, modification or failure to perform normal maintenance – see Owner's Manual. Any other expense. CONSEQUENTIAL DAMAGES, INCIDENTAL DAMAGES, OR INCIDENTAL EXPENSES INCLUDING DAMAGE TO PROPERTY. SOME STATES DO NOT ALLOW THE EXCLUSION OR LIMITATION OF INCIDENTAL OR CONSEQUENTIAL DAMAGES SO THE ABOVE LIMITATION OR EXCLUSION MAY NOT APPLY TO YOU.

HOW TO OBTAIN WARRANTY PERFORMANCE

U.S. Customers- Locate nearest service station (see www.crosman.com or call Crosman customer service at 800-724-7486 for list of stations). The service station will give you details of how to proceed with sending the item in for repair. You must contact the station before shipping your product.

International Customers- Return product to your nearest distributor. If you do not know your distributor call 585-657-6161 and ask for our International Department for assistance.

IMPLIED WARRANTIES

ANY IMPLIED WARRANTIES INCLUDING THE IMPLIED WARRANTIES OF MERCHANTABILITY AND FITNESS FOR A PARTICULAR PURPOSE ARE LIMITED IN DURATION TO ONE YEAR FROM DATE OF RETAIL PURCHASE. SOME STATES DO NOT ALLOW LIMITATIONS ON HOW LONG AN IMPLIED WARRANTY LASTS SO THE ABOVE LIMITATIONS MAY NOT APPLY TO YOU.

To the extent any provision of this warranty is prohibited by federal, state or municipal law, which cannot be pre-empted, it shall not be applicable. This warranty gives you specific legal rights and you may also have other rights, which vary, from state to state.

CROSMAN is a registered trademark of Crosman Corporation in the United States.

